

SYNTHORUS²

TRIPLE PATH ANALOG CHORUS



User Manual

Table of Contents

Requirements	3
Preliminary information	4
Overview	5
Signal flow	6
Basic modules	6
Delay Line section	6
LFO section	7
Delay line mixer	8
Master section	9
Path of the signal's flow	10
Preset Management	9
Preset storage	9
Browsing presets	10
Sources	11
Filter	11
Groups and tags	11
Results	12
Preset filtering using Groups and Tags	13
Basic Actions	13
Group operator	13
Filter enable / disable	14
Other types of filtering	14
Searching by name	14
Filtering Favorite presets	14
Filtering Pinned presets	15
Info pane	16
Browser's visual adjustments	17
Folding sections	17
Resizing columns	17
Editing presets	18
Preset selection for Edit	18
Preset renaming	18
Preset deletion	19
Tags editing	19
Author editing	21
Description editing	21
Setting presets as Favorites	22
Pinning presets	22
Preset exchange	23
Export	23
Import	24
Importing Patterns	24

Creating custom Tags and Groups structure.....	24
Adding custom Tags	24
Editing custom Tags.....	25
Adding custom Groups	25
Editing custom Groups	26
Unassigned Tags	26
Configuration	27
MIDI Learn.....	27
Linking a parameter to MIDI CC	27
Unlinking a parameter from MIDI CC	28
Loading / Saving a MIDI CC Map.....	28
Quality settings	28
GUI	29
Size.....	29
System Scale	29
Theme	29
Default Settings	29
Changing default settings.....	29
Restoring factory defaults	30

Requirements

Software and hardware requirements of the product



OS version	Windows 7 or newer
CPU	2.5 GHz SSE (Multicore 2.8 GHz recommended)
RAM	8 GB (16 GB Recommended)
Software	VST2 / VST3 / AAX compatible host application (32bit or 64bit)



OS version	OS X 10.13 or newer
CPU	Intel based 2.5 GHz (2.8 GHz recommended), Apple M1
RAM	8 GB (16 GB Recommended)
Software	AU / VST2 / VST3 / AAX compatible host application (64bit!)

Hardware requirements / recommendations are based on estimates performed on available computers at D16 Group HQ, and therefore cannot cover all possible configurations available on the market. CPU usage may vary widely depending on the manner in which the product is used. Factors that may contribute to variance in CPU usage include particular patch and its complexity, the global quality setting, project sample rate. In order to form a better understanding of how a plug-in will behave within your current setup, we highly recommend downloading the demo and giving it a try.

Preliminary information

This chapter contains general advice for using the plug-in's interface.

To do a right-click on macOS with single button mice:

Either use your **mouse click** while holding the **CTRL key** on your keyboard or use **two fingers** on your **touchpad**.

Checking the value of a parameter

Right-click on any parameter to check its value in its context menu:

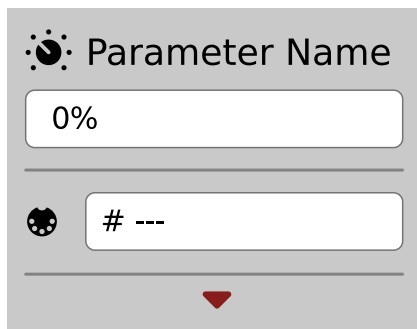

A parameter's context menu

Note: It's currently not possible to enter a precise value in the input box; it's just to check the value.

Fine-tuning continuous parameters

Tweak a control (knob) while holding the **CTRL key** (on **Windows**) or **Apple CMD** key (on **macOS**) - this will make the tweaking more precise while moving the mouse pointer up and down.

Double-click to reset a continuous parameter's value

Double-clicking on a parameter restores its value to the initial state, either default (right after loading the plug-in / loading it along a project file) or from the most recently loaded preset.

Overview

Syntorus 2 is an analogue-style chorus effect based on a triple **BBD** (*Bucket Brigade Device*) delay line, and featuring three freely configurable **LFOs**. Upon loading the plug-in in any **VST**, **Audio Units** or **AAX** host application, the GUI appears:



Syntorus 2's graphical interface

The interface comprises two main sections:

- **Configuration and preset management** (the top-most section)



The configuration and preset management section

- **Signal processing** (all other controls)

Signal flow

In this chapter, we'll describe the signal path through **Syntorus 2**, and explain each component and its controls along the way.

Basic modules

Each of the four modules that make up **Syntorus 2** is housed within its own section in the GUI:

- **Line** – Controls for the three **Delay Lines**.
- **LFO** – Controls for the three **LFOs**.
- **Mixer** – Controls for blending and panning the three **Delay lines**.
- **Master** – Controls for routing the **LFOs** to the **Delay Lines**, activating **BBD mode**, and adjusting the **Dry/Wet mix** and final **output level**.

Delay Line section

Syntorus 2 features three **BBD Delay lines**, the parameters of which are adjusted in the **Line** section of the interface.



The Line section

To switch the visible controls to any of the three delay lines, click the **Line 1, 2 or 3** LED in the section's header bar.



Click the Line 1, 2 and 3 LEDs to switch between Delay Lines

A single delay line is governed by the following parameters:



The Delay Line parameters

- **Offset** – The base (minimum) time by which the input signal is delayed, expressed in milliseconds, from 0 – 20 ms.
- **Depth** – The maximum amount of delay time modulation applied by the assigned LFO(s), expressed in milliseconds, from 0 – 20 ms. Therefore, delay time modulation ranges from **Offset** (minimum) to **Offset + Depth** (maximum).
- **Tremolo** - Applies a tremolo effect (amplitude modulation) to the **Delay Line's** output.
- **Filter** – Select the type of filter inserted into the **Delay Line's** output.
 - **Off** – Disables the filter
 - **Low Pass** – Attenuates all frequencies above the cutoff frequency
 - **High Pass** – Attenuates all frequencies below the cutoff frequency
 - **Band Pass** – Attenuates all frequencies above and below a narrow range centred on the cutoff frequency
- **Cutoff** – Controls the filter cutoff frequency.
- **Modulation** – Sets the depth of cutoff frequency modulation by the assigned LFO(s).

The **Depth**, **Tremolo** and **Modulation** parameters determine the amount of delay time (**Depth**), filter cutoff (**Modulation**) and amplitude (**Tremolo**) modulation applied by the LFO or LFOs assigned in the **Configuration** panel, described later.

The diagram below shows the signal flow through a single **Delay Line**:

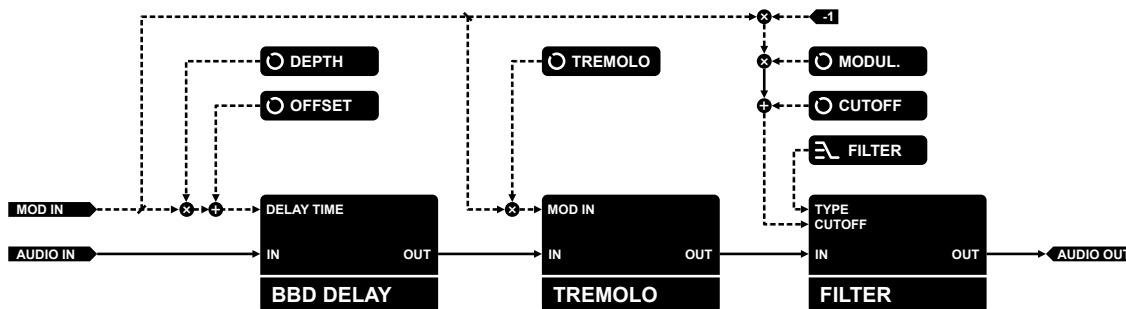

The signal flow through a single Delay line

LFO section

Syntorus 2's three LFOs are used to modulate each **Delay Line's** delay time, filter cutoff and amplitude. They're individually adjusted in the **LFO** section.



The LFO section

To select an **LFO** generator for editing, click the **LFO 1, 2** or **3** LEDs in top bar of the section.

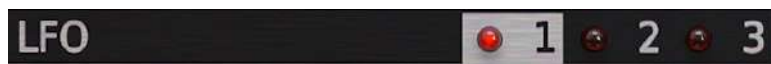

Switch between LFOs by clicking the LFO 1, 2 and 3 LEDs

All three **LFOs** share the same set of parameters:



Parameters for a single LFO

- **Rate** – Controls the cycle frequency of the **LFO**, from 0.01 – 20 Hz.
- **Waveform** – Selects the **LFO** waveform: *Sine, Triangle, Hyper Triangle, Ramp Down (sawtooth), Square* or *sample + hold*.
- **Amplitude** – Governs the amplitude of the oscillations. When set in the negative range, the waveform is inverted.
- **Phase L / Phase R** – Shift the oscillator phase for the *Left* and *Right* channels independently.
- **Sync** – Activate to sync the **LFO** to the clock/tempo of the host application. The **Rate** slider scale will change from Hz to musical note values, and three note type modifiers are available:
 - **Full** – The **LFO's** cyclical period length is equal to the full note value set by the **Rate** slider at the host tempo.
 - **Dotted** – The **LFO's** cyclical period length is equal to the dotted note value set by the **Rate** slider at the host tempo.
 - **Triplet** – The **LFO's** cyclical period length is equal to the triplet note value set by the **Rate** slider at the host tempo. A **Dotted** note is $\frac{3}{2}$ longer than the equivalent **Full** note; and a **Triplet** note is $\frac{2}{3}$ the length of the equivalent **Full** note:

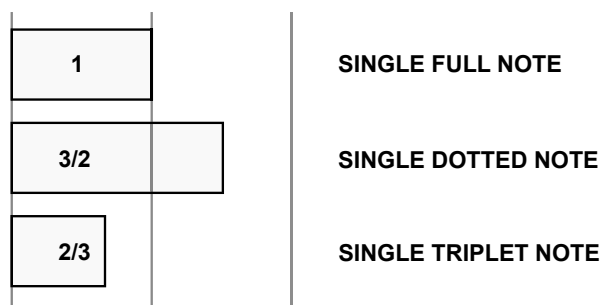

The relative lengths of Full, Dotted and Triplet notes

Delay line mixer

This section enables mixing of the signals output by the three **Delay lines**.



The Mixer section

Each channel / column in the mixer represents a single **Delay line**, and all three channels share the same controls:

- **VU Meter** – Shows the output signal level for the **Delay Line**.
- **Pan** – Controls the *left / right* balance of the **Delay Line**.
- **Vol** – Controls the output volume level of the **Delay Line**.

Master section

The final stage governs the **Output Volume** and **Dry/Wet** mix, **LFO** routing and **BBD Emulation** mode.



Master section

- **Configuration** – Sets the routing scheme for assigning the three **LFOs** to the three **delay lines**. Three topologies are available:
 - **Independent** – Each **LFO** is assigned to its respective delay line (**LFO1** to **BBD1**, **LFO2** to **BBD2**, and **LFO3** to **BBD3**)
 - **Summed** – The three **LFO** output signals are summed and routed to all three delay lines
 - **Mixed** – the signals from **LFOs 1 and 2** are summed and routed to **Lines 1 and 2**. **LFO 3** is routed to **Line 3**
- **Analog BBD Emulation** – **Syntorus 2's** discrete-time analogue **BBD** (*Bucket Brigade Device*) delay line delivers an „ideal“ clean emulation by default, but activating **Analog BBD Emulation** delivers a warmer and even more authentic analogue sound, at the expense of greater system overhead.
- **FX** – Sets the proportional balance of unprocessed and processed signal at the final output.
- **Output volume** – Controls the final amplification level.

Path of the signal's flow

The diagram below shows the signal flow through **Syntorus 2**:

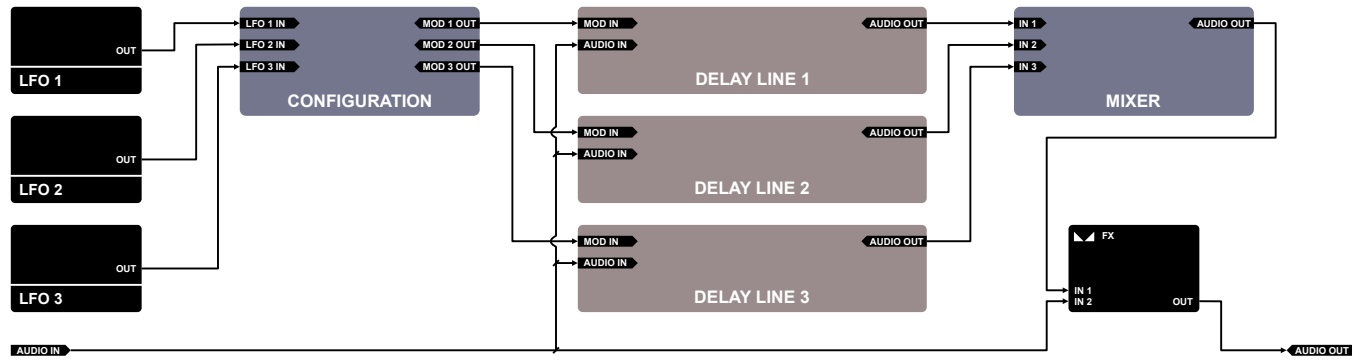

Syntorus 2 signal flow

Preset Management

Preset storage

Presets, both from **Factory** content and user ones, are stored as files in proper locations on the disc. Each time a plug-in instance is loaded into a project, these locations are scanned and the presets found there are consolidated into a single linear structure (list) in the **Preset Browser**.

Browsing presets

The **Preset management section** (no matter what kind of preset it concerns) enables quick navigation and browsing of the preset structure:



The Preset management section

- **PRESET** - Displays the name of the currently loaded preset. Clicking the display opens the **Preset Browser** panel, allowing you to browse factory / user presets.
- **Prev / Next** - Hovering over right side of the **Preset** display exposes the **Prev / Next** buttons: They allow for linear browsing of the presets list (depending on currently set filters - see sections below).
- **Save** - Saves current parameters as a new preset or allows for overwriting of the existing one (see sections below).

Right-clicking over the **Preset** display opens a context menu with two or three additional options:

- **Init** - Restores initial settings of plug-in parameters.
- **Reload** - Reloads the most recently loaded preset.
- **Save** - See description above.

The **Preset Browser** looks as follows:

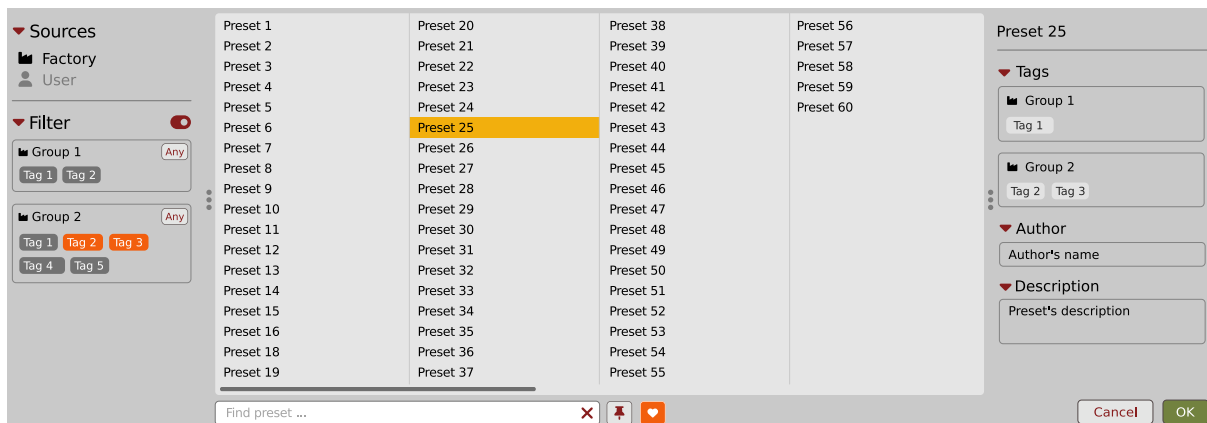

The Preset Browser

There are four main parts:

- **Sources** - Situated in the left column, filter content **Sources** for displayed presets.
- **Filter** - Below **Sources**, a preset **Filter** that uses the **Tags** system.
- **Results** - List of presets (shown in the middle column) from **Sources** that meet criteria set in the **Filter**.
- **Info pane** - The right column shows information about the currently selected preset(s), divided into several subsections.

If available - For some preset types this button can be hidden and accessible from the contextual menu (accessible via right mouse-click on **Preset display**)
 If available

Sources

In this section, you can choose a **Source** / **Source(s)** that you want to browse presets from.

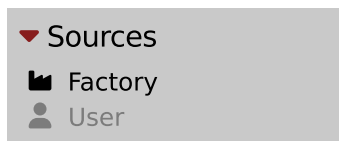

Preset Sources

There are two resources to choose from:

- **Factory** - Delivered together with the plug-in and cannot be modified (read-only).
- **User** - Created by the user and can be freely modified or shared with other users.

Choosing any of them will cause the results to narrow to the presets from one resource.

Filter

The section below is the **Filter**, which represents a preset filtering system using **Groups** and **Tags** to browse the content.

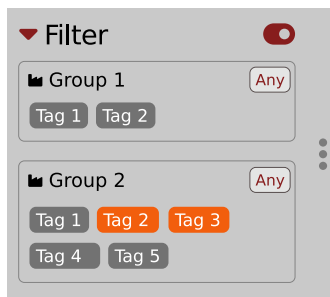

The Filter section

Groups and tags

Each **Preset** is described by a few common **Groups**. Within each of them there may be one or more **Tags** from a particular set.

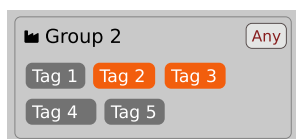

The Filter group

Presets from the **Factory** resource were assigned **Groups** and **Tags** when they were created.

Groups and **Tags** describe the content clearly, taking into account the plug-in's purpose.

Editing of the **Groups** and **Tags** for **Factory** content is limited. User presets can be described with the same **Groups** and **Tags** as **Factory** content, or you may define additional **Tags** within factory **Groups** and even create your own **Groups** with your own **Tags** to describe your own presets.

The only limitation is that a user cannot remove factory **Groups** or **Tags** from **Factory** content.

Results

This is a list of presets from chosen **Sources** that meet the filtering criteria. The basic function of this section is to browse and load presets. It can also be used for editing, which is described later.

Preset 1	Preset 20	Preset 38	Preset 56
Preset 2	Preset 21	Preset 39	Preset 57
Preset 3	Preset 22	Preset 40	Preset 58
Preset 4	Preset 23	Preset 41	Preset 59
Preset 5	Preset 24	Preset 42	Preset 60
Preset 6	Preset 25	Preset 43	
Preset 7	Preset 26	Preset 44	
Preset 8	Preset 27	Preset 45	
Preset 9	Preset 28	Preset 46	
Preset 10	Preset 29	Preset 47	
Preset 11	Preset 30	Preset 48	
Preset 12	Preset 31	Preset 49	
Preset 13	Preset 32	Preset 50	
Preset 14	Preset 33	Preset 51	
Preset 15	Preset 34	Preset 52	
Preset 16	Preset 35	Preset 53	
Preset 18	Preset 36	Preset 54	
Preset 19	Preset 37	Preset 55	

The Results list

- **Click** any name to choose and load the preset.
- **Double-click** the name to choose, load the preset and close the browser.

Hitting the **OK** button confirms loading a preset and closes the browser. Using **Cancel** closes the browser but reverts all parameter changes that loading a new preset might have caused.

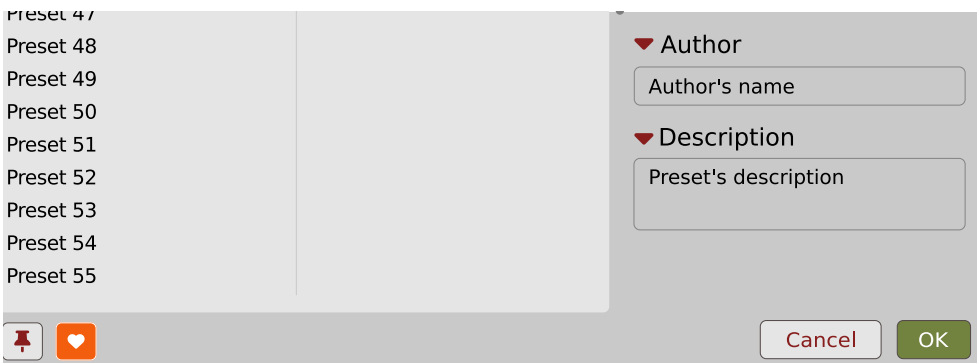

The OK and Cancel buttons in the browser

Using the **X** icon has the same effect as the **OK** button:

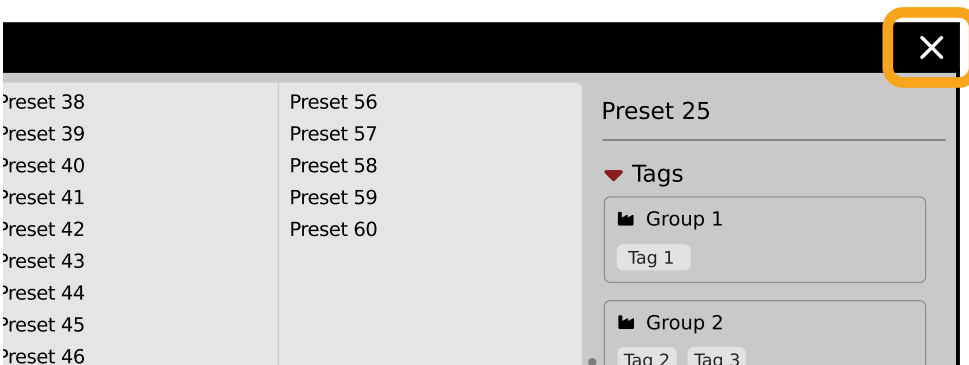

Close Browser window

Preset filtering using Groups and Tags

The **Filter** section contains **Groups** of **Tags**. Each Group is represented by a rectangle with the **Group** name + set of **Tags** inside.

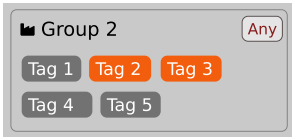

Group 2 with two tags set (Tag 2 and Tag 3)

The filtering process cascades from top to bottom. This means that all presets available in the selected **Sources** are filtered by selected **Tags** from the first **Group** (uppermost one), then the **Group** below and so on, until filtered by the last active **Group** (the bottom one).

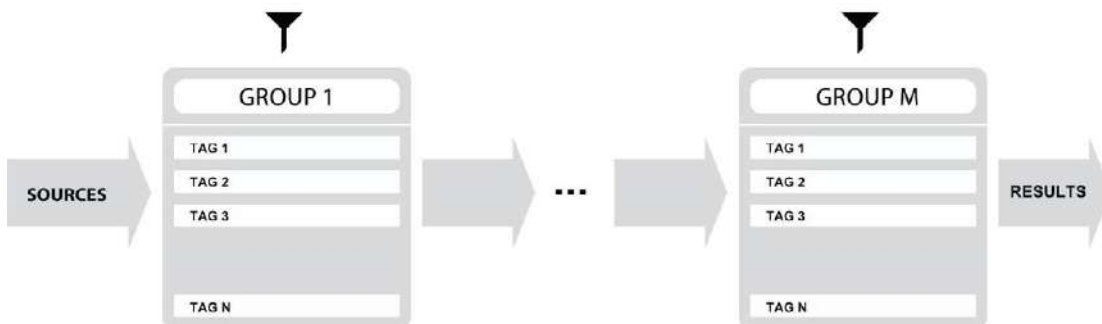

Preset Filtering with the use of Groups

The result of the cascade filtering process is listed in the middle column, the **Results** / presets list section. You can also consider the **Results** list as an intersection of preset sets, found by filtering through every individual **Group**.

Basic Actions

Tags work as toggle buttons. Click to *activate* / *deactivate* a **Tag**; a gray background color means that the **Tag** is inactive, and orange means that the **Tag** is *active*.

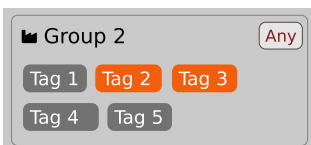

Group 2 with two tags set (Tag 2 and Tag 3)

If at least one **Tag** in a **Group** is active, then the **Group** (filter) also becomes active, otherwise the **Group** chosen doesn't affect the filtering process at all.

Group operator

When a single **Tag** is active in a **Group**, only presets having that **Tag** set are displayed in the **Results**.

If two or more **Tags** in a **Group** are active, the **Results** depend on the **Operator** chosen for the **Group**:

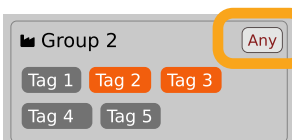

A Group operator

The **Operator** button works in toggle mode and offers a choice of two alternative **Operators** for the **Group**:

- **Any** - Means that a preset is shown in the **Results** when the preset includes at least one of the active **Tags** from the **Group**.
- **All** - Means that a preset is shown in the **Results** only when the preset includes all active **Tags** from the **Group**.

Filter enable / disable

You can quickly enable / disable the **Filter** using the toggle switch in the top-most section of the **Filter**:

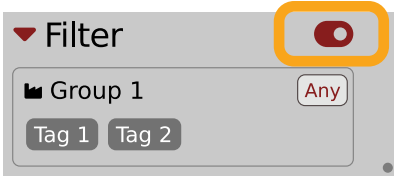

An On/Off switch for a Group Filter

Other types of filtering

Searching by name

Alternatively, you can look for a preset by entering its name or just a piece of its name into the **Find preset** field:



The Find preset input

The **Results** are refreshed on-the-fly and they work together with the other filters.

Using the **X** icon clears the entire field:



Clearing the search field

Filtering Favorite presets

You can mark presets as a **Favorite** by clicking the **Heart** icon while hovering on preset name . You can unmark presets by clicking the icon again (toggle mode):



Setting a preset as a Favorite on the list

- Logical OR between Tags in the Group
- Logical AND between Tags in the Group
- It's allowed for every **source** (**factory** or **user**)

The flag is stored globally, meaning that a **Favorite** preset will be accessible as such from every other instance of the plug-in 📌.

Once you have your **Favorite** presets flagged, you can quickly filter them using the toggle button with a **Heart** icon on it:



Favorite presets filtering

If the button is active, then only **Favorite** presets will be shown (considering all remaining filters).

Filtering Pinned presets

You can **Pin** one or more presets using the **Pin** icon while hovering over a preset name 📌. You can unpin a preset by clicking the icon again (toggle mode):

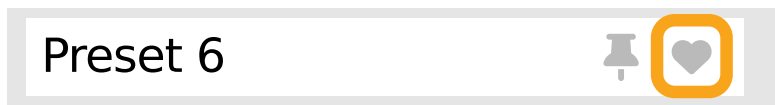

Pinning a preset on the list

Unlike **Favorites**, this flag works locally and it's stored with the project file (not global config), so **Pins** are stored individually for every instance (with total recall, so a plug-in state is recalled if saved in the context of a project).

But, similarly to **Favorites**, you can easily filter presets using the toggle button with the **Pin** symbol on it:



Pinned presets filtering

If the button is active, then only **Pinned** presets will be shown (considering all remaining filters).

Info pane

The column to the right shows information about the selected preset or presets. It also provides access to some of the preset editing functions.

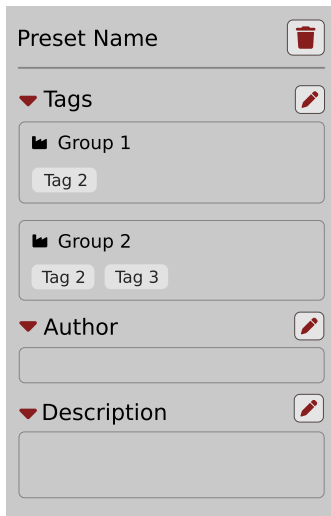

The Info pane

There's a preset name at the top.

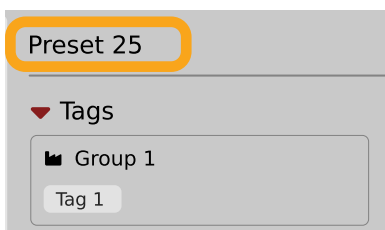

The Preset name in the Info pane

Additionally, if you've selected more than one preset there's information about how many more have been selected:

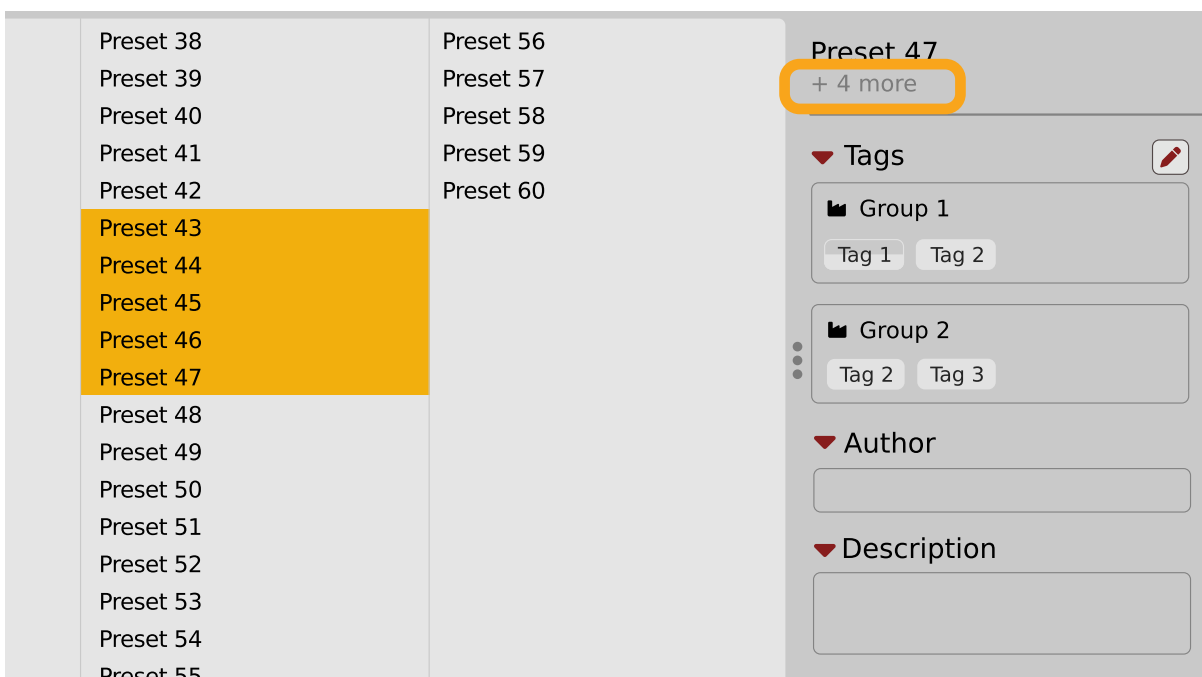

Selecting more than one preset

Below the preset(s) name there are few common sections describing selected presets:

- **Tags**
- **Author**
- **Description**

Browser's visual adjustments

Folding sections

If you don't need to see the contents of every section / subsection, you can fold some of them up using the **Caret** icons:

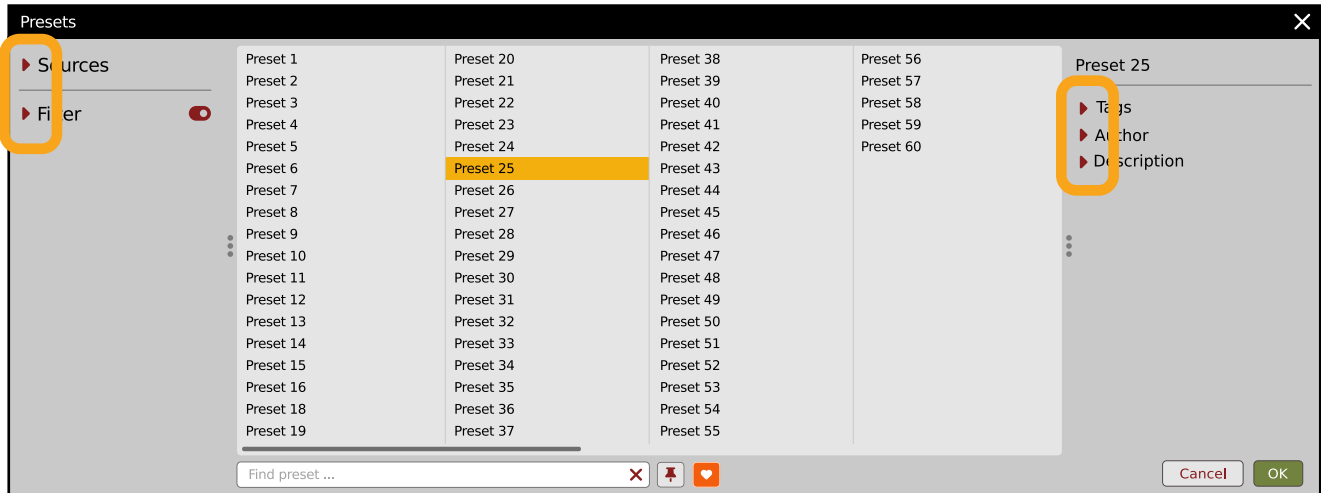

Sections folded up

Resizing columns

You can use the three-dotted handles to change a column's width to your preference.

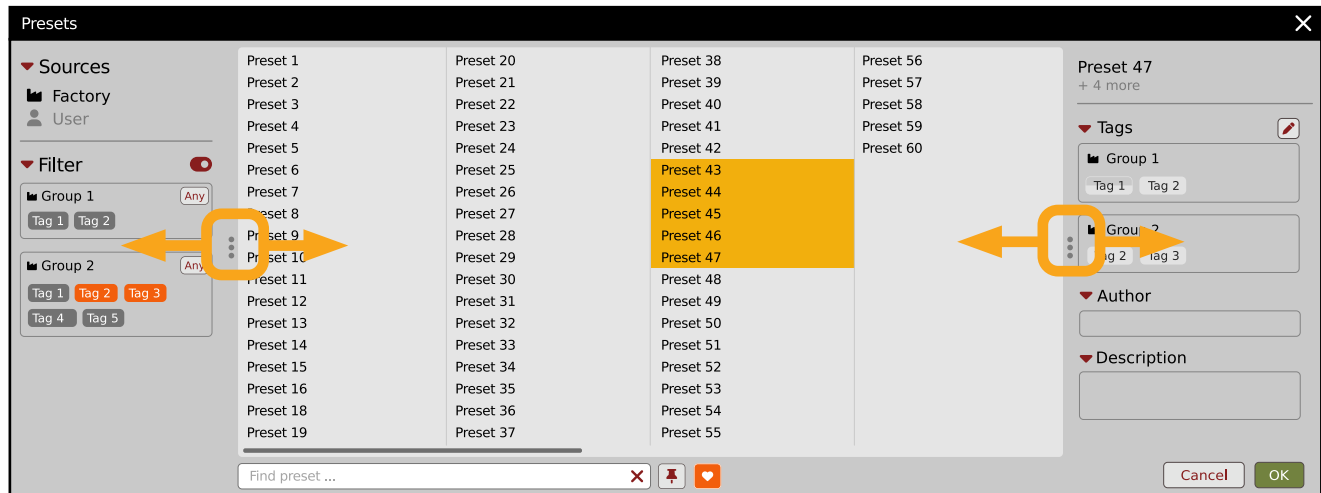

Resizing Browser columns

Editing presets

You can perform certain actions on presets, such as adjusting **Groups** and **Tags**, deletion, renaming the presets as well as their export or import. One should bear in mind, however, that some operations are only allowed on user presets but not on **Factory** content.

Preset selection for Edit

Some operations can be done on more than one preset, so you're allowed to select more than one preset at once; in the **Results** section, you can choose a preset or a set of presets in the following ways:

- **Click a preset** - Selects (and loads) one preset from the list.
- Win (**Ctrl**) + **Click the preset**), Mac (**Cmd** + **⌘**) + **Click the preset**) - Adds another preset to an already chosen preset or a set of presets.
- **Shift + Click the preset** - Selects a range of presets from the last chosen preset to the preset clicked with the *Shift* key.
- Right-Click on any **Preset** in the **Results** section and choose the **Select All** option - this selects all presets:

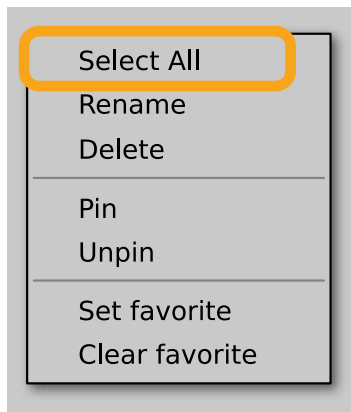

Selecting all presets

Preset renaming

On a selected preset **▶**, right-click to open the context menu and select the **Rename** option:

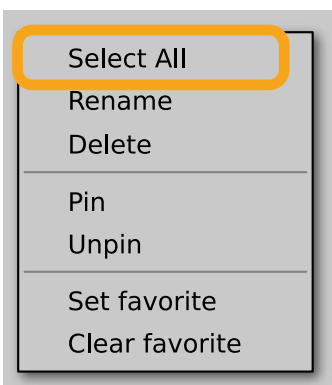

Preset renaming

▶ The option is available only for individual presets and won't work on a selection of two or more presets.

Preset deletion

Once you have selected one or more presets, right-click to open the context menu and select the **Delete items**  option:

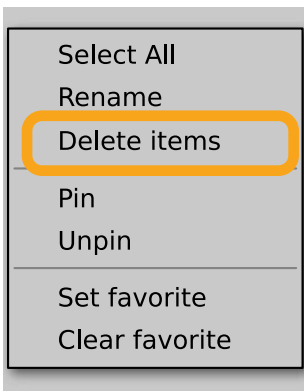

Deleting presets

Alternatively, you can use the **Trash bin** button in the **Info pane** to delete selected presets:



The Trash bin button

Tags editing

When you select a preset or presets to change their tags, click the **Pencil** button next the **Tags** section in the **Info pane** to enter **Edit mode** for the **Tags**:

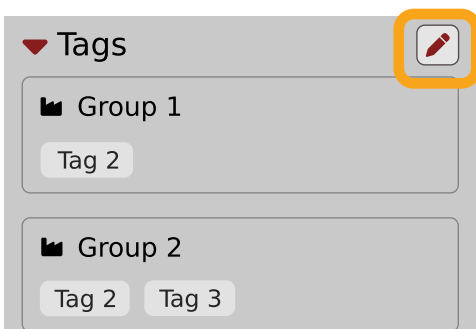

Entering the Tag edit mode

 Or **Delete** option (depending on how many presets have been selected).

With the **Edit mode** enabled, you will see all possible **Groups** and **Tags** available for the preset(s):

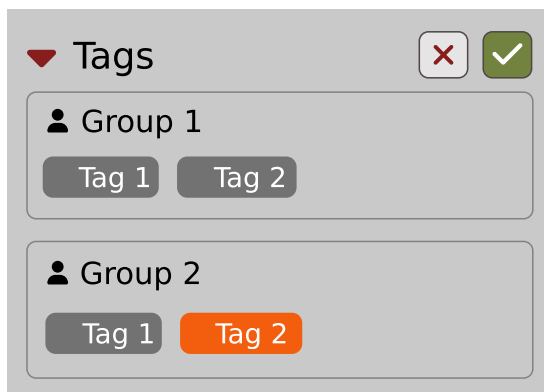

The Tag Edit mode

Tag buttons work in toggle mode, much like filtering. Clicking them either sets or erases a **Tag** for a chosen preset. If a **Tag** is set for a preset, it is indicated by an orange background color, whereas if a **Tag** is not set, it has a gray background color.

If you choose multiple presets with existing tags, **Tag** buttons will appear orange if a specific **Tag** appears in all selected presets, and gray if it appears in none.

When a specific **Tag** is set only for a few of the selected presets, it appears as half-gray and half-orange.

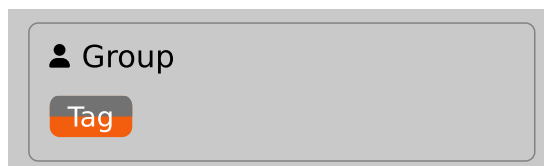

Tags appearing only in part of selection

Changing the **Tag** status for one or more chosen presets sets or erases this **Tag** in all these presets. A status change is signaled by an **Asterisk** to the left of a **Tag**.



A Tag with a status change

Tag buttons highlighted in half-gray and half-orange color (where **Tag** values across the highlighted presets aren't all the same) work in a three-state system when switching between states; they turn gray if you erase the **Tag** for all selected presets, orange if you set the **Tag** for all selected presets, and return to half-gray and half-orange if the selected items remain unchanged or are returned to their initial state.

Potential changes have to be confirmed using the **OK / Cancel** buttons at the top part of the **Tags** section:



Confirmation buttons in the Tags section

Author editing

When you select a preset or presets to change the **Author**, click the **Pencil** button next the **Author** section in the **Info pane** to enter the **Edit mode** for the **Author** field:

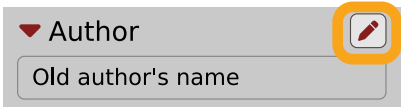
 A screenshot of a software interface showing a dropdown menu labeled 'Author' with a downward arrow. Below it is a text input field containing 'Old author's name'. To the right of the dropdown is a pencil icon, which is highlighted with a yellow circle.

Editing Author

Once you've finished editing the field, confirm the operation using the **OK / Cancel** buttons:

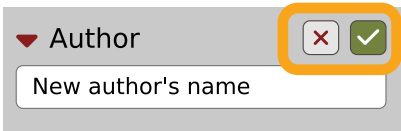

 A screenshot of the software interface showing the 'Author' dropdown menu. The text input field now contains 'New author's name'. To the right of the input field are two buttons: a red 'X' (cancel) and a green checkmark (OK). Both buttons are highlighted with a yellow circle.

Confirming Author editing

This operation is possible for user content only.

Description editing

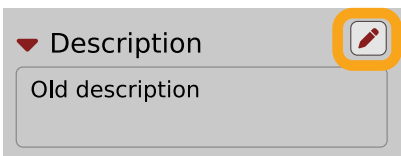
When you select a preset or presets to change the **Description**, click the **Pencil** button next the **Description** section in the **Info pane** to enter the **Edit mode** for the **Description** field:

 A screenshot of a software interface showing a dropdown menu labeled 'Description' with a downward arrow. Below it is a text input field containing 'Old description'. To the right of the dropdown is a pencil icon, which is highlighted with a yellow circle.

Editing Description

Once you've finished editing the field, confirm the operation using the **OK / Cancel** buttons:

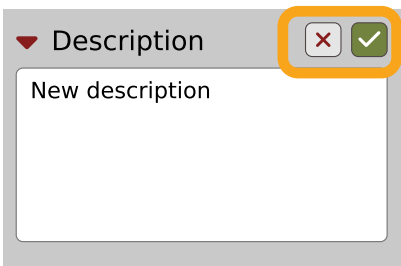
 A screenshot of the software interface showing the 'Description' dropdown menu. The text input field now contains 'New description'. To the right of the input field are two buttons: a red 'X' (cancel) and a green checkmark (OK). Both buttons are highlighted with a yellow circle.

Confirming Description editing

This operation is possible for user content only.

Setting presets as Favorites

As described in the chapters above, you can mark a preset as a **Favorite** by clicking the **Heart** icon while hovering over the preset name:



Setting a preset as a Favorite

The flag is stored globally, meaning that a **Favorite** preset will be accessible as such from every other instance of the plug-in ▶ .

It's also possible to perform the operation for a selection of presets. After you select the desired presets in the **Results** window, right-click on the presets to open a context menu:

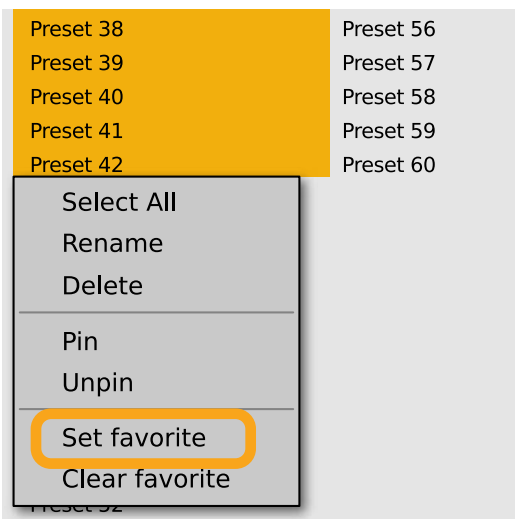

Setting Favorite presets from the context menu

And select the **Set favorite** option.

To clear **Favorite** flags for the selection of presets, use the **Clear favorite** option instead.

Pinning presets

You can **Pin** one or more presets using the **Pin** icon while hovering over the preset name:



Pinning a preset

Unlike **Favorites**, this flag works locally and it's stored with the project file (not globally). This means the **Pins** are stored individually for every instance (with total recall, so a plug-in state is recalled if saved in the context of a project).

▶ Sometimes a project or plug-in reload may be required

It's also possible to perform the operation for a selection of presets. After selecting the desired presets in the **Results** window, right-click on the presets list to open the context menu:

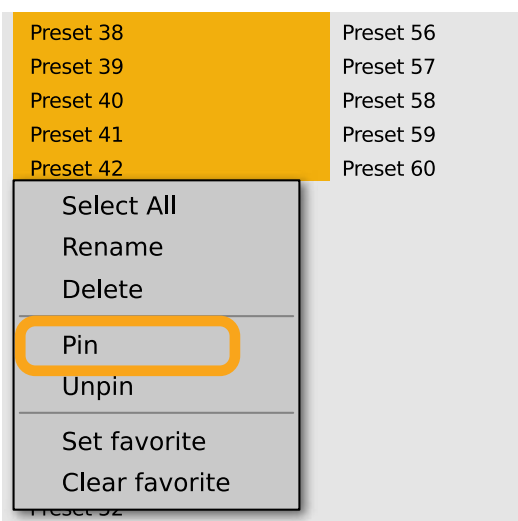

Pinning presets from selection

And select the **Pin** option.

To clear the **Pin** flag for a selection of presets, use the **Unpin** option instead.

Preset exchange

If you want to make a backup, or exchange a preset with a collaborator, you can export / import selected presets.

Export

Select a preset or presets that you're going to export and drag-and-drop them outside your DAW into a location you'd like to store them:

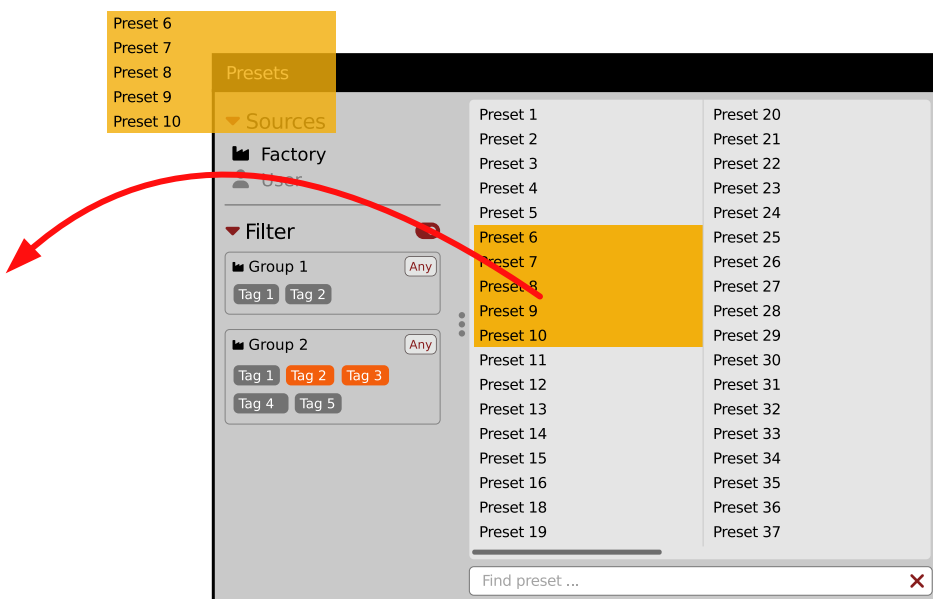

Exporting presets

The presets will be saved as individual files (one per preset) in the plug-in's native format.

Import

If you'd like to import preset files, you can drag-and-drop preset files from where they're stored, into the preset browser:

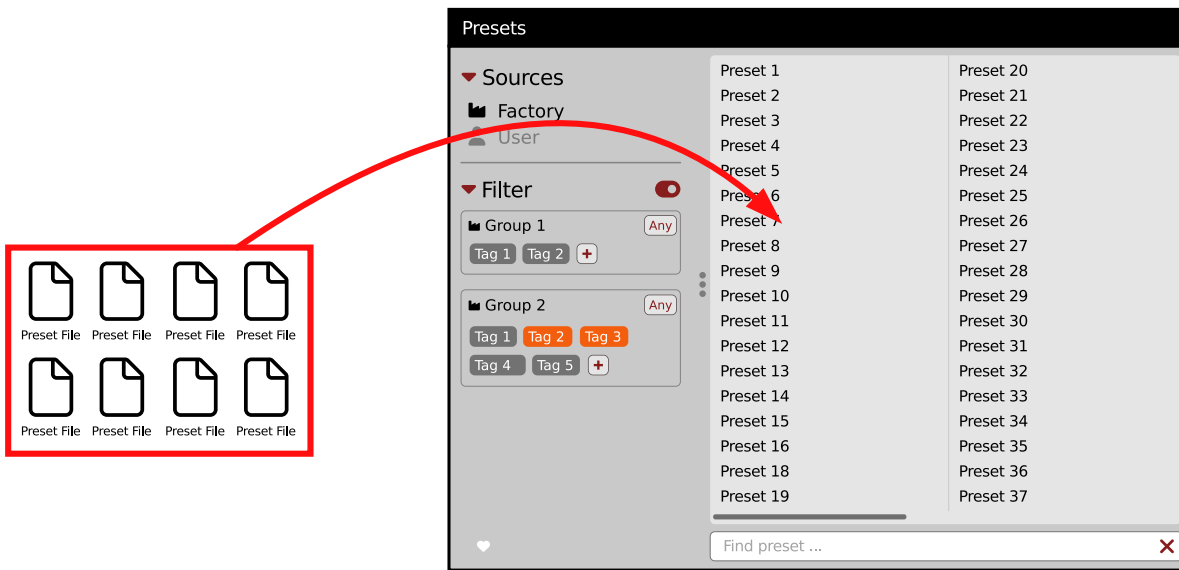

Importing presets

They will be automatically imported as user presets.

Importing Patterns

Specifically within the **Pattern browser**, it's possible to import:

- Native **Phoscyon 2** patterns.
- Banks from legacy versions of the plug-in (**Phoscyon 1.x**) - which will be accessible as alternative **Sources**, after you drag-and-drop them into the **Browser**.
- Patterns from *Audiorealism ABL 2* or *3* instruments - which will be included in **User** patterns after import.

Creating custom Tags and Groups structure

Adding custom Tags

Users are allowed to add their own custom **Tags** to both their own content and factory content. To add a new **Tag** to an existing filter **Group**, click over the **Group's** name to pull down a menu and select the **Add Tag** option .



Adding a new Tag

You can do this either in the **Info Pane** (right column, while the **Tag edit** mode is enabled) or **Filter** (left column).

 This operation is allowed for a user's Groups only

Editing custom Tags

There are a few edit options available for a user to perform on their own **Tags**, which are available by right-clicking a **Tag's** name in the **Filter** section:

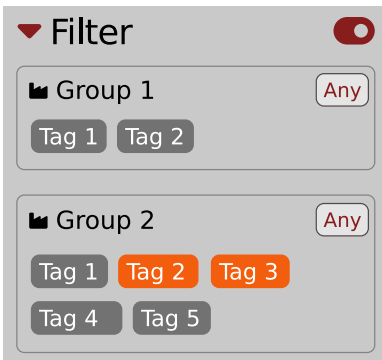

The Filter section

You will see a context menu with all the available options:

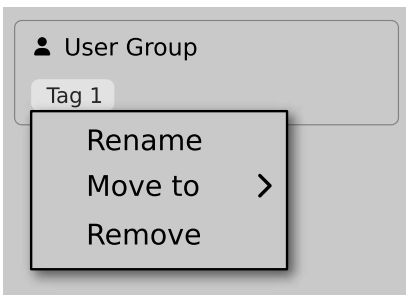

Editing options for a user Tag

- **Rename** - Changes the name of a **Tag**.
- **Move to** - Moves a **Tag** to another **Group**.
- **Remove** - Deletes a **Tag**.

The menu is accessible only for a user's own **Tags**.

Adding custom Groups

You can add a custom filter to **Groups** by clicking the **Filter** label and selecting the **Add Group** option from the pull-down menu:



Adding a user Group

From here, you can add **Tags** to that newly created **Group** (see above), or move **Tags** from other **Groups**.

You can also add a custom filter to **Groups** in the **Info Pane** (right column) or **Filter** (left column).

Editing custom Groups

There are a few edit options available for a user to perform on their own **Groups**. Click on a **Group's** name in the **Filter** section:

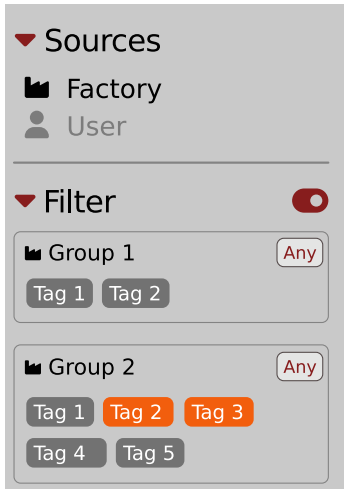

The Filter section

You will see a context menu with the following options:

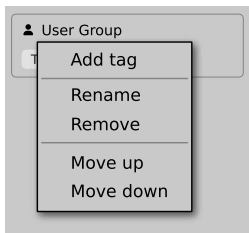

Edit options for a user Group

- **Add Tag** - Adds a new tag to the **Group** (described earlier).
- **Rename** - Changes the **Group's** name.
- **Remove** - Deletes the **Group**, possible only when all **Tags** in the **Group** have also been removed.
- **Move up** - Moves a **Group** up in the **Filter**. Possible unless the **Group** is already the topmost one.
- **Move down** - Moves a **Group** down in the **Filter**. Possible unless the **Group** is the last one.

These operations are possible only on user **Groups**.

Groups in the **Filter** are ordered with **Groups** from **Factory** content first, then user groups below.

You can edit user **Groups** in either the **Info Pane** (right column, while **Edit mode** for **Tags** is enabled) or **Filter** (left column).

Unassigned Tags

When you receive content from a collaborator who uses different **Tags** and **Groups**, some Tags may show as **Unassigned**. This happens if the filter structure made by a preset's author is different.

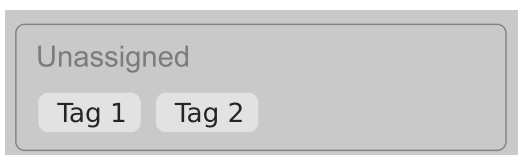

Unassigned Tags

You can move the **Tags** across your **Groups** to make them fit your scheme, or re-tag the collaborator content entirely.

Configuration

MIDI Learn

Right-click any plug-in parameter to open the context menu:

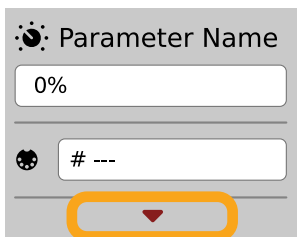

A context menu

Left-clicking outside the menu area closes it automatically.

Clicking the bottom arrow expands the menu and displays all available options:

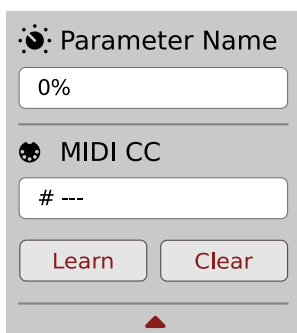

An expanded context menu

Linking a parameter to MIDI CC

The **Learn** function enables a quick assignment of physical controllers (from a MIDI controller) to plug-in parameters.

1. Click the **Learn** button to put the plug-in into a pending state before moving any MIDI CC controller.
2. Once the CC is recognized, click **OK** to save the change or click the **Cancel** button to restore the previous setting.

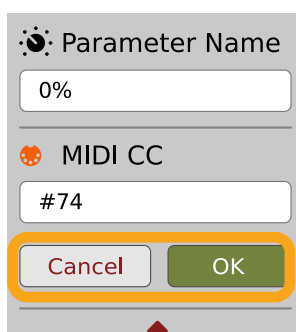

Linking a parameter to MIDI CC

Unlinking a parameter from MIDI CC

You can also delete a MIDI CC code attributed to a parameter from the context menu:

1. From the context menu, click the **Clear** button:

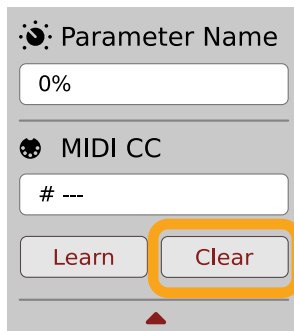

The Clear MIDI CC button

2. Then confirm using the **OK** button.

Loading / Saving a MIDI CC Map

These options are available in the **MIDI** submenu, accessible under **Cog** icon in the left-upper corner:

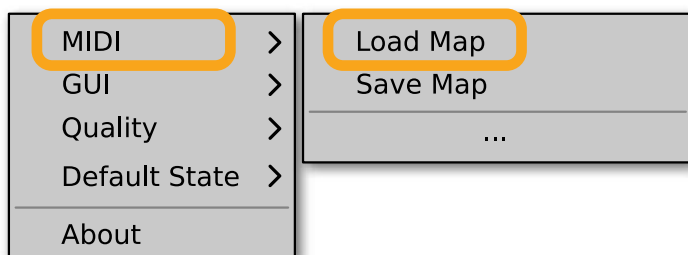

The Load Map and Save Map options

- **Save Map** - Saves the current MIDI CC map to a file.
- **Load Map** - Loads a MIDI CC map from a stored file.

Quality settings

The **Quality** submenu under **Cog** icon in upper-left corner allows to choose sound quality for **Real-time** or **Offline** modes.

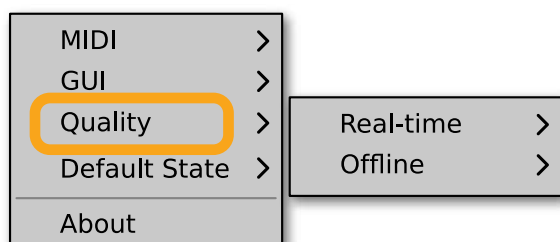

Quality settings

The higher the quality, the bigger the impact on the CPU.

GUI

The **Size**, **System Scale** and **Theme** options are accessible from **GUI** submenu under **Cog** icon in upper-left corner of the plug-in. With these, you can adjust look of the plug-in, according to the pixel density and resolution of your screen:

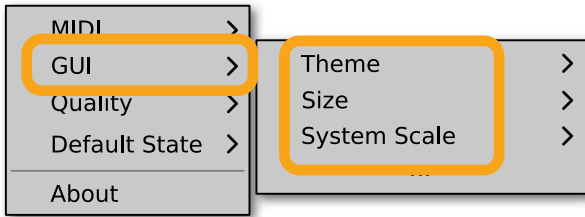

The GUI Size and System Scale options

Size

This option lets you choose one of several default skin sizes to best match the plug-in to the resolution of your computer monitor.

System Scale

System Scale controls the rescale factor for the whole plug-in. For the best visual results, you should set it to the exact value from your system settings (screen properties).

Theme

The **Theme** allows you to choose skin color variant according to your preference

Default Settings

You can save your current settings so that the plug-in will default to them for each new instance, or restore the plug-in to load with its factory settings.

Changing default settings

1. Click the **Cog** icon in the left-upper corner of the plugin.
2. Go to the **Default State** submenu and choose the **Save current** option.

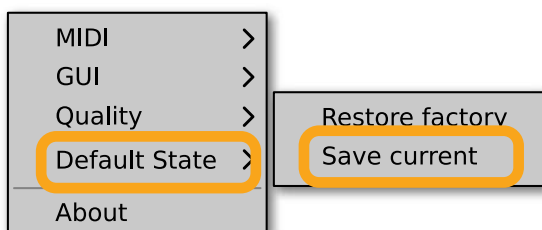

Changing the default state of the plug-in

With this option, the current plug-in state will be saved as the default / initial state for when you insert a new instance of the plug-in.

The plug-in state includes: sound parameters (default preset), views, preset filters, sound quality settings, loaded / created MIDI CC map and GUI settings.

Restoring factory defaults

To return the default state for new instances to factory settings:

1. Click the **Cog** icon in the left-upper corner of the plugin.
2. Go to the **Default State** submenu and choose the **Restore factory** option.